



Owner's Manual and Instructions

"Workman" Convection Construction Heaters



MODELS	OUTPUT (Btuh)	FUEL
CV225	225,000	Propane Vapor Withdrawal



Certification by:



Congratulations!

You have purchased the finest convection heater available.

Your new L.B. White heater incorporates the benefits from the most experienced manufacturer of heating products using state-of-the-art technology.

We, at L.B. White, **thank you** for your confidence in our products and welcome any suggestions or comments you may have...call us, toll-free, at 1-800-345-7200.

ATTENTION ALL USERS

This heater has been tested and evaluated by C.S.A. International in accordance with Standard ANSI Z83.7 • CSA 2.14 and is listed and approved as a direct fired vertical convection construction heater for use on combustible floors. This heater is intended for use as a portable, temporary heater for buildings under construction, alteration, or repair. If you are considering using this product for any application other than its intended use, then please contact your fuel gas supplier, or the L.B. White Co., Inc.



Quality heaters you can count on.

W6636 L.B. White Rd., Onalaska, WI 54650 ■ (800) 345-7200 ■ (608) 783-5691 ■ (608) 783-6115, fax ■ info@lbwhite.com

150-27644

 **GENERAL HAZARD WARNING**

- Failure to comply with the precautions and instructions provided with this heater, can result in:
 - Death
 - Serious bodily injury or burns
 - Property damage or loss from fire or explosion
 - Asphyxiation due to lack of adequate air supply or carbon monoxide poisoning
 - Electrical shock
- Read this Owner's Manual before installing or using this product.
- Only properly-trained service people should repair or install this heater.
- Save this Owner's Manual for future use and reference.
- Owner's Manuals and replacement labels are available at no charge. For assistance, contact L.B. White at 800-345-7200.

 **WARNING**

- Proper gas supply pressure must be provided to the inlet of the heater.
- Refer to data plate for proper gas supply pressure.
- Gas pressure in excess of the maximum inlet pressure specified at the heater inlet can cause fires or explosions.
- Fires or explosions can lead to serious injury, death, or building damage.
- Gas pressure below the minimum inlet pressure specified at the heater inlet may cause improper combustion.
- Improper combustion can lead to asphyxiation or carbon monoxide poisoning and therefore serious injury or death.

 **WARNING**

Fire and Explosion Hazard

- Not for home or recreational vehicle use.
- Installation of this heater in a home or recreational vehicle may result in a fire or explosion.
- Fire or explosions can cause property damage or loss of life.

FOR YOUR SAFETY

Do not store or use gasoline or other flammable vapors and liquids in the vicinity of this or any other appliance.

FOR YOUR SAFETY

If you smell gas:

1. Open windows.
2. Don't touch electrical switches.
3. Extinguish any open flame.
4. Immediately call your gas supplier.

 **WARNING**

Fire and Explosion Hazard

- Keep solid combustibles a safe distance away from the heater.
- Solid combustibles include wood or paper products, building materials, and dust.
- Do not use the heater in spaces which contain or may contain volatile or airborne combustibles.
- Volatile or airborne combustibles include gasoline, solvents, paint thinner, dust particles or unknown chemicals.
- Failure to follow these instructions may result in a fire or explosion.
- Fire or explosions can lead to property damage, personal injury or loss of life.



Table of Contents

SECTION	PAGE
General Information	3
Heater Specifications	4
Safety Precautions	5
Installation Instructions	
General	7
Hose and Regulator Assembly	8
Connecting Regulator to Propane Gas Supply	8
Start-Up Instructions	9
Shut-Down Instructions	9
Cleaning Instructions	10
Maintenance Instructions	10
Service Instructions	
General	11
Safety Control Valve / Variable rate Valve / Burner Orifice Manifold	11
Thermocouple	12
Igniter and Electrode	12
Gas Pressure Checks	13
Troubleshooting	14
Heater Component Function	15
Parts Identification	
Parts Schematic	16
Parts List	17
Warranty Policy	18
Replacement Parts and Service	18

General Information

This Owner's Manual includes all options and accessories commonly used on this heater. However, depending on the configuration purchased, some options and accessories may not be included.

When calling for technical service assistance, or for other specific information, always have model number, configuration number and serial number available. This information is contained on the dataplate.

This manual will instruct you in the operation and care of your unit. Have your qualified installer review this manual with you so that you fully understand the heater and how it functions.

The gas supply line installation, installation of the heater, and repair and servicing of the heater requires continuing expert training and knowledge of gas heaters and should not be attempted by anyone who is not so qualified. See page 6 for definition of the necessary qualifications.

Contact your local L.B. White distributor or the L.B. White Co., Inc. for assistance, or if you have any questions about the use of the equipment or its application.

The L.B. White Co., Inc. has a policy of continuous product improvement. It reserves the right to change specifications and design without notice.

Heater Specifications

SPECIFICATIONS		Model
Fuel		CV225 Propane Gas
Input (BTUH)	MAX.	225,000
	MIN.	45,000
Inlet Gas Supply Pressure Acceptable at the Gas Connection of the Heater(PSIG)	MAX.	10.2
	MIN.	10.2
Burner Manifold Pressure (PSIG)		10
Fuel Consumption Per Hour (Lbs. / hour)	MAX.	10.4
	MIN.	2.1
Dimensions (Inches) L x W x H		17 x 15 x 26
Minimum Safe Distances From Nearest Combustible Materials	TOP	5 ft. 10 in.
	SIDES	4 ft.
	GAS SUPPLY	6 ft. (1.83 m.)

Safety Precautions

WARNING **Asphyxiation Hazard**

- Do not use this heater for heating human living quarters.
- Do not use in unventilated areas.
- The flow of combustion and ventilation air must not be obstructed.
- Proper ventilation air must be provided to support the combustion air requirements of the heater being used.
- Lack of proper ventilation air will lead to improper combustion.
- Improper combustion can lead to carbon monoxide poisoning leading to serious injury or death. Symptoms of carbon monoxide poisoning can include headaches, dizziness and difficulty in breathing.

FUEL GAS ODOR

Propane gas and natural gas have man-made odorants added specifically for detection of fuel gas leaks.

If a gas leak occurs, you should be able to smell the fuel gas.

THAT'S YOUR SIGNAL TO GO INTO IMMEDIATE ACTION!

- Do not take any action that could ignite the fuel gas. Do not operate any electrical switches. Do not pull any power supply or extension cords. Do not light matches or any other source of flame. Do not use your telephone.
- Get everyone out of the building and away from the area immediately.
- Close all propane gas tank or cylinder fuel supply valves, or the main fuel supply valve located at the meter if you use natural gas.
- Propane gas is heavier than air and may settle in low areas. When you have reason to suspect a propane leak, keep out of all low areas.
- Natural gas is lighter than air and can collect around rafters or ceilings.
- Use your neighbor's phone and call your fuel gas supplier and your fire department. Do not re-enter the building or area.
- Stay out of the building and away from the area until declared safe by the firefighters and your fuel gas supplier.
- **FINALLY**, let the fuel gas service person and the firefighters check for escaped gas. Have them air out the building and area before you return. Properly trained service people must repair the leak, check for further leakages, and then relight the appliance for you.

ODOR FADING -- NO ODOR DETECTED

- Some people cannot smell well. Some people cannot smell the odor of the man-made chemical added to propane or natural gas. You must determine if you can smell the odorant in these fuel gases.
- Learn to recognize the odor of propane gas and natural gas. Local propane gas dealers and your local natural gas supplier (utility) will be more than happy to give you a "scratch and sniff" pamphlet. Use it to become familiar with the fuel gas odor.
- Smoking can decrease your ability to smell. Being around an odor for a period of time can affect your sensitivity to that particular odor.
- The odorant in propane gas and natural gas is colorless and the intensity of its odor can fade under some circumstances.
- If there is an underground leak, the movement of gas through the soil can filter the odorant.
- Propane gas odor may differ in intensity at different levels. Since propane gas is heavier than air, there may be more odor at lower levels.
- **Always be sensitive to the slightest gas odor.** If you continue to detect any gas odor, no matter how small, treat it as a serious leak. Immediately go into action as discussed previously.

ATTENTION -- CRITICAL POINTS TO REMEMBER!

- Propane gas and natural gas have a distinctive odor. Learn to recognize these odors. (Reference "Fuel Gas Odor" and "Odor Fading" sections above.)
- If you have not been properly trained in repair and service of propane gas and natural gas fueled heaters, then do not attempt to light heater, perform service or repairs, or make any adjustments to the heater on propane gas or natural gas fuel system.
- Even if you are not properly trained in the service and repair of the heater, ALWAYS be consciously aware of the odors of propane gas and natural gas.
- A periodic sniff test around the heater or at the heater's joints; i.e. hose, connections, etc., is a good safety practice under any conditions. If you smell even a small amount of gas, CONTACT YOUR FUEL GAS SUPPLIER IMMEDIATELY. DO NOT WAIT!



WARNING
Burn Hazard

- High surface and discharge temperatures.
- Do not touch the heater or come within safe clearances given on dataplate.
- Use extreme caution when lighting the heater or adjusting heat levels.
- Failure to follow this warning and come too close to the heater can result in burns or ignition of clothing.
- Burns cause serious injury or death.

1. Do not attempt to install, repair, or service this heater or the gas supply line unless you have continuing expert training and knowledge of gas heaters.

Qualifications for service and installation of this equipment are as follows:

- a. To be a qualified gas heater service person, you must have sufficient training and experience to handle all aspects of gas-fired heater installation, service and repair. This includes the task of installation, troubleshooting, replacement of defective parts and testing of the heater. You must be able to place the heater into a continuing safe and normal operating condition. You must completely familiarize yourself with each model heater by reading and complying with the safety instructions, labels, Owner's Manual, etc., that is provided with each heater.
 - b. To be a qualified gas installation person, you must have sufficient training and experience to handle all aspects of installing, repairing and altering gas lines, including selecting and installing the proper equipment, and selecting proper pipe and tank size to be used. This must be done in accordance with all local, state and national codes as well as the manufacturer's requirements.
2. All installations and applications of L.B. White heaters must meet all relevant local, state and national codes. Included are L.P. gas, natural gas, electrical, and safety codes. Your local fuel gas supplier, a local licensed electrician, the local fire department or similar government agencies, or your insurance agent can help you determine code requirements.

Also refer to:

- ANSI/NFPA 58, latest edition, Standard for Storage and Handling of Liquefied Petroleum Gas
 - ANSI Z223.1/NFPA 54, National Fuel Gas Code
3. Adequate ventilation air for combustion must be provided in accordance with OSHA 29 CFR 1926.154, Temporary Heating Devices, and ANSI A10.10, Safety Requirements for Temporary and Portable Space Heating Devices.
 4. We cannot anticipate every use which may be made of our heater. Check with your local fire safety authority if you have questions about applications.

5. Other standards govern the use of fuel gases and heat producing products in specific applications. Your local authority can advise you about these.
6. Use only compressed air, soft brush or dry cloth to clean the interior of the heater and its components.
7. Always use approved pipe thread compound suitable for use with propane gas on the threaded connections.
8. Do not block air intakes or discharge outlets of the heater. Doing so may cause improper combustion or damage to heater components leading to property damage.
9. The hose assembly shall be visually inspected on a daily basis after heater relocation and when the heater is in use. If it is evident there is excessive abrasion or wear, or if the hose is cut, it must be replaced prior to the heater being put into operation. The hose assembly shall be protected building materials, and contact with hot surfaces during use. The hose assembly shall be that specified by the manufacturer. See parts list.
10. Check for gas leaks and proper function upon heater installation or when relocating. Refer to leak check instructions within installation section of this manual.
11. This heater should be inspected for proper operation by a qualified service person before each use and at least annually.
12. Always turn off the gas supply to the heater if the heater is not going to be used in the heating of the work space.
13. If gas flow is interrupted and flame goes out, do not relight the heater until you are sure that all gas that may have accumulated has cleaned away. In any event, do not relight the heater for at least 5 minutes.
14. Minimum propane gas supply cylinder size to be used shall be 100 pounds. When using a cylinder supply system, the system must be arranged to provide vapor withdrawal from the operating cylinder.
15. When the heater is to be stored indoors, the connection between the propane gas supply cylinder(s) and the heater must be disconnected and the cylinder(s) removed from the heater and stored in accordance with the Standard and Handling of Liquefied Petroleum Gases, ANSI/NFPA 58.
16. Propane gas supply containers have left handed threads. Always use the appropriate wrench to tighten or loosen the P.O.L. fitting at the propane gas containers supply valve. Do not use pliers.



WARNING

Fire or explosion hazard.

Can cause property damage, severe injury or death.

1. To avoid dangerous accumulation of fuel gas, turn off the gas supply at the heater service valve before starting installation, and perform gas leak test after completion of installation.
2. Do not force the gas control button. Use only normal hand pressure to depress the button. Never use any tools. If the button will not operate by normal hand pressure, the control should be replaced by a qualified service technician. Force or attempted repair may result in fire or explosion.

1. Read all safety precautions and follow L.B. White recommendations when installing this heater. If during the installation or relocating of heater, you suspect that a part is damaged or defective, call a qualified service agency for repair or replacement.
2. Position heater properly before use. The heater must be installed on a level, flat, horizontal and stable surface when hot or in operation and according to minimum clearances from combustible surfaces such as walls, floor or ceilings. Do not place combustible materials within this zone of clearance. Minimum safe distances are as follows:

Top to Ceiling	5 ft. 10 in.
All Sides	4 ft.
Gas Supply	6 ft.

3. L.P Gas Installation Requirements

- Ensure all L.P. gas containers are secured and protected from people, vehicular traffic and contact.
- L.P. gas containers must be located on a flat, level, and stable surface.
- L.P. gas cylinders (100 lb. cylinders/tanks) must be secured from tip-over.

Contact your local authorities, L.P. gas dealers, or fire marshalls for specifics dealing with installation in your area.

4. Position the heater and its gas supply hose so as to protect heater and its gas supply hose from traffic. Protect hoses with a shielding device of suitable nature to protect the hose from traffic and movement or other construction equipment.
5. The heater is approved for indoor use only. The heater shall be installed so it is not directly exposed to water spray, rain, and /or dripping water.

6. The heater's gas pressure regulator (with pressure relief valve) must be protected from adverse weather conditions (rain, ice, snow) as well as from building materials (tar, concrete, plaster, etc.) which can affect safe operation and could result in property damage or injury.
7. Heaters used in the vicinity of combustible tarpaulins, canvas, plastics, wind barriers, or similar coverings shall be located at least 10 feet from the coverings. The coverings shall be securely fastened to prevent ignition or upsetting of the heater due to wind action on the covering or other material.
8. Check all connections for gas leaks using approved gas leak detectors. Gas leak testing is performed as follows:



WARNING

Fire and Explosion Hazard

- Do not use open flame (matches, torches, candles, etc.) in checking for gas leaks.
- Use only approved leak detectors.
- Failure to follow this warning can lead to fires or explosions.
- Fires or explosions can lead to property damage, personal injury or loss of life.

- Check all pipe connections, hose connections, fittings and adapters upstream of the gas control with approved gas leak detectors.
- In the event a gas leak is detected, check the components involved for cleanliness and proper application of pipe compound before further tightening.
- Furthermore tighten the gas connections as necessary to stop the leak.
- After all connections are checked and any leaks are stopped, turn on the main burner.
- Stand clear while the main burner ignites to prevent injury caused from hidden leaks that could cause flashback.
- With the main burner in operation, check all connections, hose connections, fittings and joints as well as the gas control valve inlet and outlet connections with approved gas leak detectors.
- If a leak is detected, check the components involved for cleanliness in the thread areas and proper application of pipe compound before further tightening.
- Tighten the gas connection as necessary to stop the leak.

- If necessary, replace the parts or components involved if the leak cannot be stopped.
 - Ensure all gas leaks have been identified and repaired before proceeding.
9. A qualified service agency must check for proper operating gas pressure upon installation of the heater.
 10. Light according to instructions on heater or within owner's manual.
 11. Make sure the heater has the proper gas regulator for the application. A regulator must be connected to the gas supply so that gas pressure at the inlet to the gas valve is regulated within the range specified on the dataplate at all times. Contact your gas supplier, or the L.B. White Co., Inc. if you have any questions.
 12. This heater is configured for use with propane vapor withdrawal only. Consult the heater's dataplate for the gas configuration of the specific heater. Do not use the heater in a propane liquid withdrawal system or application. If you are in doubt, contact the L.B. White Co., Inc.
 13. Take time to understand how to operate and maintain the heater by using this Owner's Manual. Make sure you know how to shut off the gas supply to the building and also to the individual heater. Contact your fuel gas supplier if you have any questions.
 14. Any defects found in performing any of the service or maintenance procedures must be eliminated and defective parts replaced immediately. The heater must be retested by properly qualified service personnel before placing the heater back into use.

HOSE AND REGULATOR ASSEMBLY

1. Apply a small amount of pipe thread sealant to threads of rigid hose connection. Connect this end to regulator inlet. See Fig.1 Tighten securely.
2. Connect opposite end of hose with nut to safety control valve at heater. See Fig.2. Tighten securely.

FIG. 1

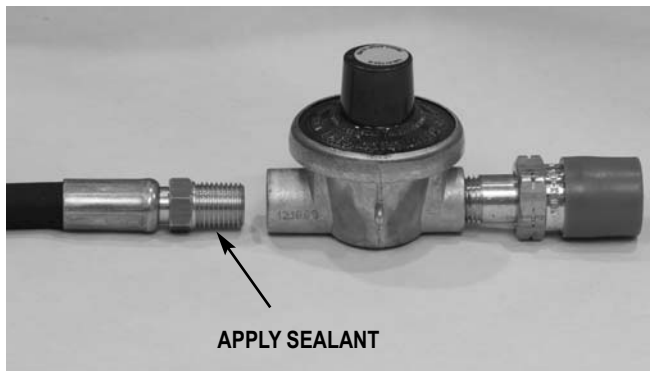

FIG. 2



CONNECTING REGULATOR TO PROPANE GAS SUPPLY

1. Remove protective cap from POL fitting. Do not discard cap. Position regulator as shown.
 2. Insert POL fitting into propane supply valve. See Fig.2. Thread nut on fitting counterclockwise into propane supply valve. Tighten nut securely with a wrench.
- When storing or transporting the heater, ensure the cap is pushed onto the POL fitting to prevent damage or dirt entry into regulator.

FIG. 3



Start-Up Instructions

WARNING
Burn Hazard

- Before lighting, ensure the variable heat valve on heater is located in **minimum** heat output position. See Fig.4.
- Failure to do so will result in the main burner igniting at full heat output.
- Serious injury or death due to burns may occur.

1. Slowly open the fuel supply valve at the gas supply.
(This prevents lockup of the excess flow check valve internal to the regulator's POL fitting.)
2. Fully depress the button on the safety control valve while pushing the igniter button. The burner will light. See Fig. 4.

FIG. 4

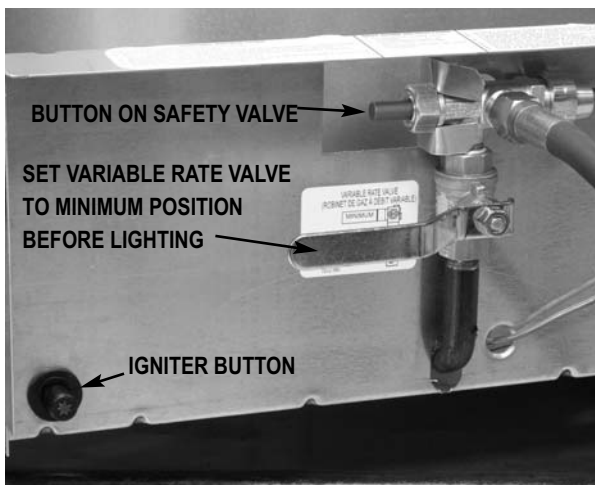

- On new installations it may take a short time for gas to purge out any air before the burner lights.
3. Keep the valve button depressed for about 30 seconds to allow the thermocouple to warm up.
 4. Release the safety control valve button.
 4. Once the burner is lit, the variable rate valve can be positioned to any setting from minimum to maximum heat. See Fig.5

FIG. 5

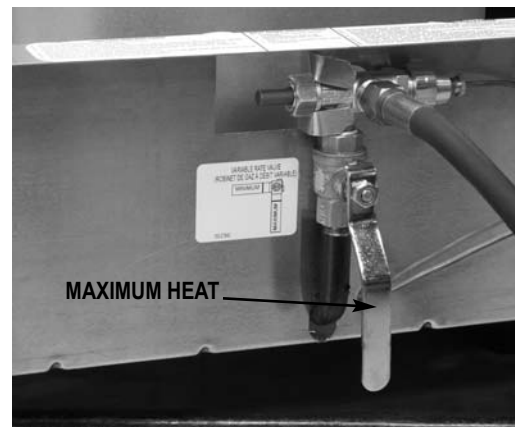

Shut-Down Instructions

1. Close all fuel gas supply valves.
2. Allow the heater to burn off any fuel gas remaining in the gas supply line.
3. Position the variable rate valve to its minimum heat position.
4. Disconnect the heater from its gas supply.

Cleaning Instructions

 **WARNING**
Fire, Burn, and Explosion Hazard

- This heater contains mechanical components used in the gas management and safety systems.
- Such components may become inoperative or fail due to dust, dirt, wear or aging.
- Periodic cleaning and inspection as well as proper maintenance are essential to avoid serious injury or damage.

1. Before cleaning, close all gas supply valves.
2. The heater should have dirt or dust removed periodically:
 - a. Before each use give the heater a general cleaning using compressed air, a soft brush, or dry rag, on its case and internal components.
 - b. At least once a year, give the heater a thorough cleaning. At this time, remove the case assembly and brush and/or blow off the burner and related components.

 **WARNING**

Do not use a pressure washer, water or liquid cleaning solution on any gas controls. Use of a pressure washer, water, or liquid cleaning solution on the control components can cause severe personal injury or property damage due to water and/or liquids:

- * On gas control valves causing corrosion which can result in gas leaks and fire or explosion from the leak.

Clean all components of the heater with a pressurized air, a dry brush or a dry cloth.

Maintenance Instructions

1. The area surrounding the heater shall be kept clear and free from combustible materials, gasoline, and other flammable vapors and liquids.
2. Have your gas supplier check all gas piping annually for leaks or restrictions in gas lines.
3. Regulators must be periodically inspected to make sure the regulator vents are not blocked. Debris, insects, insect nests, snow, or ice on a regulator can block vents and cause excess pressure at the appliance.
4. Regulators can wear out and function improperly. Have your gas supplier check the date codes on all regulators installed and check delivery pressures to the appliance to make sure that the regulator is reliable.
5. Check all wiring associated terminals and electrical components within the heater for corrosion, frayed or cut insulation, tight connections, etc. Repair or replace as necessary.
6. Review all heater markings (i.e. warnings, start-up, shut-down, etc.) at the time of maintenance for legibility. Make sure none are cut, torn, or otherwise damaged. Any damaged markings must be replaced immediately by contacting the L.B. White Co., Inc. Dataplates, start-up and shut-down instructions and warnings are available at no cost.

GENERAL

WARNING
Burn Hazard

- Heater surfaces are hot for a period of time after the heater has been shut down.
- Allow the heater to cool before performing service, maintenance, or cleaning.
- Failure to follow this warning will result in burns causing injury.

WARNING
Fire and Explosion Hazard

- Do not disassemble or attempt to repair any heater components or gas train components.
- All component parts must be replaced if defects are found.
- Failure to follow this warning will result in fire or explosions, causing property damage, injury, or death.

1. Close the fuel supply valve to the heater before servicing unless necessary for your service procedure.

2. Disconnect the thermocouple from the safety control valve when servicing either the pilot safety control valve or the burner orifice manifold.
3. Remove the heater's barrel for access to burner related components.
4. Disconnect the gas hose if needed for the service procedure.
5. For reassembly, reverse the respective service procedure. Ensure gas connections are tightened securely.
6. After servicing, start the heater to ensure proper operation and check for gas leaks.
7. Clean the heater's orifice manifold with compressed air or a soft, dry rag. Do not use files, drills, etc., which may enlarge the holes, causing combustion problems or burner flame extending outside of the case barrel. Replace the manifold if its holes cannot be cleaned properly.

SAFETY CONTROL VALVE/VARIABLE RATE VALVE/BURNER ORIFICE MANIFOLD

1. Straighten the mounting bracket tabs and remove thermocouple from safety control valve.
2. Remove the jam nut securing the safety control valve to its mounting bracket.
3. Pull the safety control with manifold from heater.
4. Replace or clean components as needed.

FIG. 6

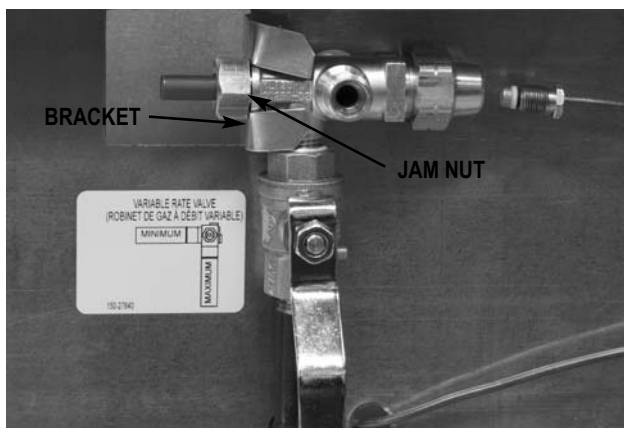
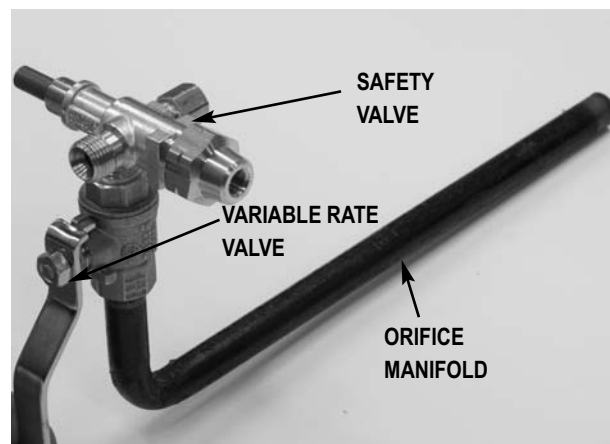

FIG. 7



THERMOCOUPLE

The thermocouple may need replacement if the burner goes out after allowing the thermocouple to heat up for an extended period of time.

1. Pull back on the thermocouple to disengage it from its mounting bracket.
2. Loosen the thermocouple connector nut which is threaded into the safety control valve. Slide the thermocouple through the bushing at the back of the heater.

- The thermocouple uses a clip to mount within its support bracket. See Fig.8. Ensure the thermocouple is completely pushed into its bracket. Failure to do so may cause burner outage.
- When connecting the thermocouple to the safety control valve, thread the thermocouple finger tight to the valve, then snug it in with a wrench.

To determine if the thermocouple is defective:

- Connect an ohm meter between the ends of the thermocouple.
- A good thermocouple will show some level of resistance from end to end.
- A defective thermocouple will show an open circuit on the ohm meter

FIG. 8



IGNITER and ELECTRODE

Servicing of the igniter and electrode is needed when a spark is not observed at the electrode when pushing the igniter button. This may happen with hard use over a long period of time, or due to dust and dirt accumulation.

If you do not see a spark being generated at the electrode check the following areas:

A. Igniter

1. Remove the wire from the push button igniter.
2. Position a screwdriver tip) about 1/8 in. from igniter. See Fig.9
3. Holding the screwdriver by its handle, push the igniter's button several times. If spark is not seen, replace the igniter. If spark is observed, proceed to electrode servicing.

B. Electrode

1. Ensure the wire between the electrode and the igniter is securely connected.
2. Check the wire for nicks, cuts, or mars. Nicks or cuts will prevent a spark from being generated at the electrode tip. Replace the electrode if necessary. The electrode ships with the wire.
3. Ensure electrode tip is 5/32 in. (.156) from inside of burner. Clean the electrode with emery cloth or steel wool. See Fig.10.
4. Verify that the electrode's insulator body is not cracked and that the electrode rod does not move within its the body. See Fig.11. If it does, replace the electrode.

FIG. 9



FIG. 10

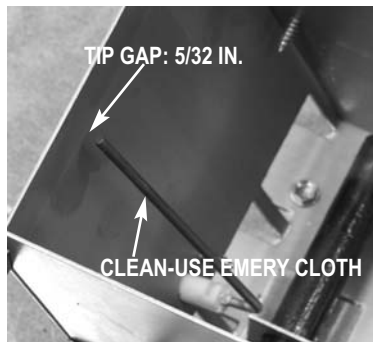
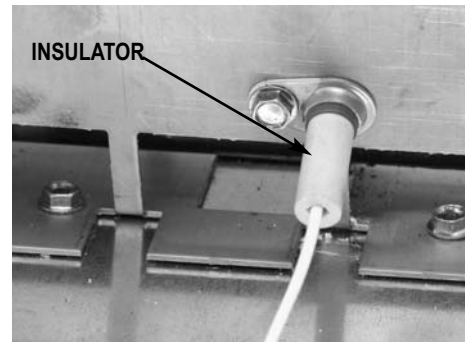

FIG. 11



- This procedure is to be done once a year prior to the heating season, anytime the heater is moved from one job location to the next, or after servicing the heater.

⚠ WARNING

- Do not disassemble the safety control valve.
- Do not attempt to replace any components of the safety control valve.
- The safety control must be replaced if any physical damage occurs to it.
- Failure to follow this warning will result in fire or explosions, leading to injury or death, and building damage.

MATERIALS REQUIRED

(To be secured through local purchase)

Quantity	Description
1	High Pressure Gas Gauge capable of reading up to 15 PSIG
1	1/8 in. black iron street ell.

A. PREPARATION

1. Close fuel supply valve at propane gas supply container.
2. Allow heater to burn off gas remaining in it's gas supply line..
3. Position the variable heat valve to its lowest setting..
4. Remove case barrel from heater.

B. GAUGE INSTALLATION

1. Using an wrench, remove the cap from the safety control valve as shown in Fig. 12

FIG.12

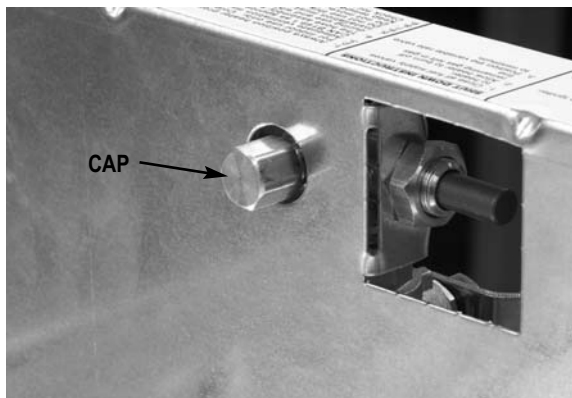

2. Install a 1/8 in. street elbow and pressure gauge at this point. See Fig.13

FIG.13



3. Open fuel supply valves to heater.

C. READING PRESSURES

1. Light the heater. Set the variable rate valve to its highest setting. With the heater operating, the pressure gauge should read the pressure specified on the dataplate or in the specification section of this owner's manual.
2. Does the pressure reading agree with that given on the dataplate? If so, no further checking or adjustment is required. Proceed to section D.
3. If the pressures does not agree with that specified on the dataplate, then check the following:
 - Improper regulator for heater.
 - Regulator out of adjustment. (Replace if necessary).
 - Blockage in gas hose.
 - Insufficient size or quantity of propane gas supply containers.

D. COMPLETION

1. Once the proper pressure has been confirmed, close fuel supply valves.
2. Allow heater to burn off fuel remaining in gas supply line.
3. Remove elbow, and gauge.
4. Install hex cap onto safety valve. Tighten securely.
5. Check for gas leaks.

Troubleshooting

<u>PROBLEMS</u>	<u>CAUSES</u>	<u>REMEDIES</u>
1. Burner will not light.	<ul style="list-style-type: none"> * Propane gas container is empty. * Fuel supply valves closed. * Excess flow valve in P.O.L. fitting on regulator is closed. * Safety control button not fully pushed in. * Burner orifice manifold is plugged. * Restriction in gas hose. * Air in gas line. 	<ul style="list-style-type: none"> * Fill container. * Open fuel supply valves. * Close propane container valve. Wait 5 minutes and open container's valve slowly. * Push in button completely. * Clean or replace manifold. * Remove hose from heater and blow out with compressed air or replace if necessary. * Push in safety control valve's pilot button (normally 15 - 20 seconds is sufficient) on control of gas valve to purge air from line (usually necessary at time of installation). <p style="margin-left: 40px;">NOTE: Make sure you are pushing the Piezo igniter button during this time to prevent gas accumulation.</p> <ul style="list-style-type: none"> * Safety control valve is defective. * Defective Piezo igniter or electrode. * Replace safety control valve. * Refer to the igniter and electrode service instruction section for problems associated with these parts.
2. Burner lights but will not stay lit when safety control button is released.	<ul style="list-style-type: none"> * Restriction in gas hose. * Insufficient time allowed for thermocouple to heat up.. * Loose thermocouple. * Defective thermocouple. * Orifice manifold is plugged. * Defective safety control valve. * Improper gas pressure. 	<ul style="list-style-type: none"> * See remedy for same cause in Problem #1. * Hold in control button for 30 seconds to allow proper warm up. * Tighten thermocouple at gas control. Make sure it is securely pushed into its bracket. Tighten finger tight and snug the contact nut with an appropriate wrench. * Replace thermocouple. * See remedy for same in Problem #1. * Replace safety control valve. * Set pressure according to pressure on dataplate.
3. Burner flame lifting off burner.	<ul style="list-style-type: none"> * Fuel pressure set too high. * Blockages in burner manifold orifice or at primary air inlets of burner. 	<ul style="list-style-type: none"> * Set pressure according to pressure on dataplate. * Clean suspected area with soft brush, dry cloth, or compressed air.
4. Heater not delivering maximum heat output.	<ul style="list-style-type: none"> * Gas supply valves not fully open. * Variable rate valve not positioned to maximum Burner manifold orifice plugged. * Low fuel supply pressure. 	<ul style="list-style-type: none"> * Open valves completely. * Position the valve to maximum * Clean burner orifice with compressed air or replace. * Consult propane gas supplier. Cylinder or tank needs replacement or refill. Regulator needs adjustment. Check for use of proper regulation and fuel gas.

Heater Component Function

BARREL w/ TOP (CASE)

Upright sheet metal case component. Acts as a chimney to distribute heat to surrounding area.

BASE

Sheet metal case platform used to support and stabilize burner and barrel assemblies.

BURNER

Component at which combustion of fuel gases takes place.

BURNER ORIFICE / MANIFOLD

Metering device used to feed gas to burner at a specific rate, with the appropriate pressure.

ELECTRODE

Ignites gas by spark. Receives spark voltage from piezo igniter.

GAS HOSE

Flexible connector used to convey gas from supply line or cylinder to heater.

PIEZO IGNITER

Generates ignition voltage when igniter button is pushed. This voltage is sent to electrode to provide spark.

REGULATOR

The heart of any gas supply installation. Used to deliver a working pressure to the appliance under varying conditions in tank pressure.

SAFETY CONTROL VALVE

A gas control valve which is held open by electrical power supplied by the thermocouple and which closes automatically to shut off the flow of gas to the main burner when flame is extinguished or is too small to heat the thermocouple.

THERMOCOUPLE

A thermoelectric device that converts heat directly into electrical energy. Works in conjunction with electromagnet in gas control valve thereby assisting in maintaining gas supply for the pilot light.

VARIABLE RATE VALVE

A manually adjusted valve that allows the user to operate the heater from its lowest to highest heat output, or anywhere in-between. .

Parts Identification

Parts Schematic

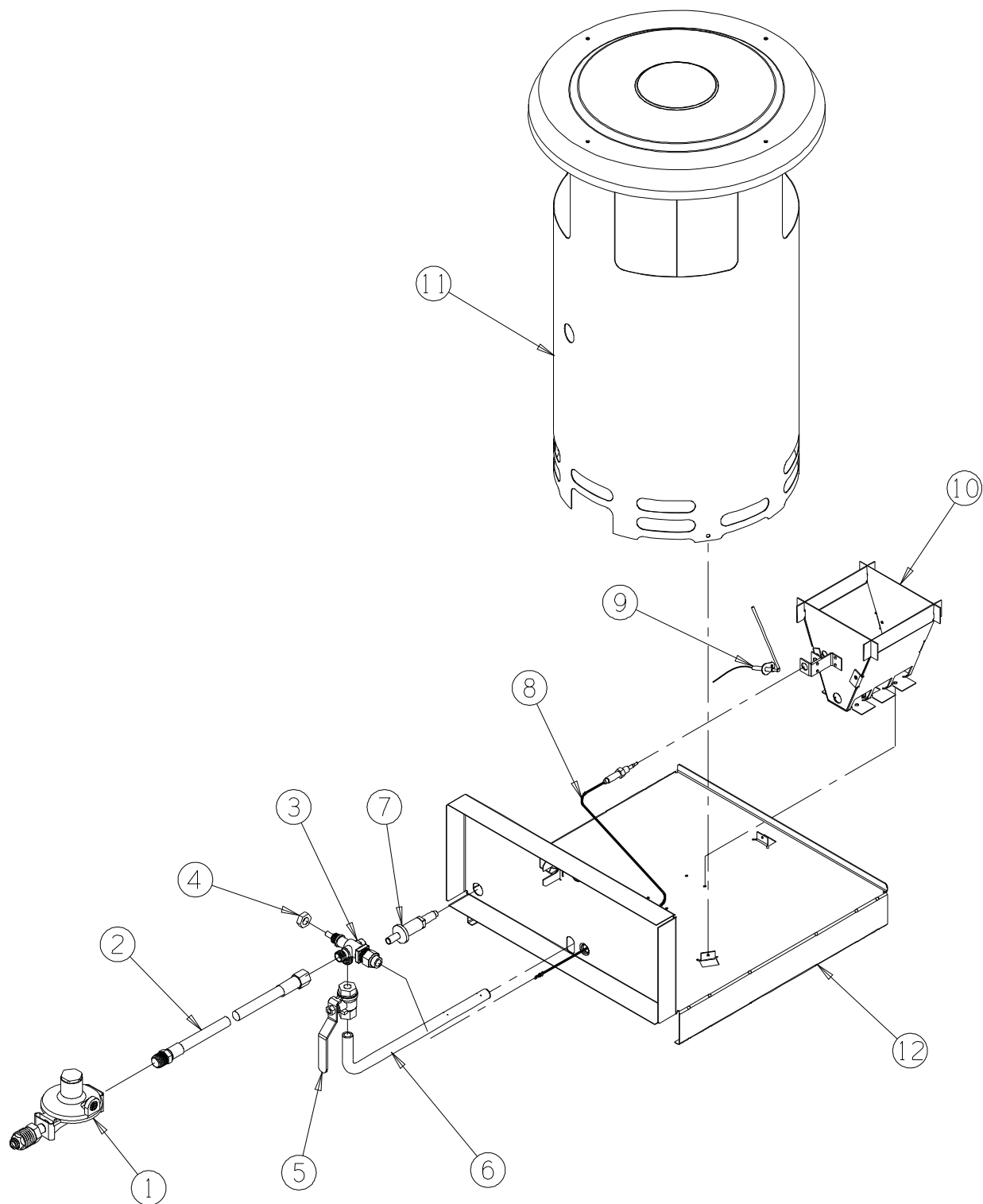

Parts List

Item	Description	Part Number
1	Regulator w/POL Fitting	23463
2	Hose, 1/4 in./ 10 ft.	20706
3	Valve, Safety Control	572506
4	Nut, Jam	572587
5	Valve, Variable Rate	572507
6	Orifice Manifold	572508
7	Igniter, Piezo	570434
8	Thermocouple	571030
9	Electrode	572509
10	Burner Assembly	572504
11	Barrel w/ Top	572505
12	Base	572510

Warranty Policy

EQUIPMENT

L.B. White Co., Inc. warrants that the component parts of its heaters are free from defects in material and workmanship, when properly installed, operated, and maintained in accordance with the Installation and Maintenance Instructions, safety guides and labels contained with each unit. If, **within 12 months from the date of purchase by the end user**, any component is found to be defective, L.B. White Co., Inc. will at its option, repair or replace the defective part or heaters, with a new part or heater, F.O.B., Onalaska, Wisconsin.

A warranty card on file at L.B. White will automatically qualify a unit and its component parts for warranty consideration. If a warranty card is not on file, a copy of the bill of sale will be required to establish warranty qualification. If neither is available, the warranty period will be 12 months from date of shipment from L.B. White.

PARTS

L.B. White Co., Inc. warrants that replacement parts purchased from the company and used on the appropriate L.B. White heater are free from defects both in material and workmanship for **12 months from the date of purchase by the end user**. Warranty is automatic if a component is found defective within 12 months of the date code marked on the part. If the defect occurs more than 12 months later than the date code but within 12 months from the date of purchase by the end user, a copy of a bill of sale will be required to establish warranty qualification.

duration to the duration of the applicable warranty stated above. The remedies set forth above are the sole and exclusive remedies available hereunder. L.B. White will not be liable for any incidental or consequential damages directly or indirectly related to the sale, handling or use of the heater, and in any event L.B. White's liability in connection with the heater, including for claims based on negligence or strict liability, is limited to the purchase price.

The warranty set forth above is the exclusive warranty provided by L.B. White, and all other warranties, including any implied warranties or merchantability or fitness for a particular purpose, are expressly disclaimed. In the event any implied warranty is not hereby effectively disclaimed due to operation of law, such implied warranty is limited in

Some states do not allow limitations on how long an implied warranty lasts, so the above limitation may not apply to you. Some states do not allow the exclusion or limitation of incidental or consequential damages, so the above limitation or exclusion may not apply to you. This warranty gives you specific legal rights, and you may also have other rights which vary from state to state.

Replacement Parts and Service

Contact your local L.B. White dealer for replacement parts and service or call the L.B. White Co., Inc. at (800) 345-7200 for assistance. Be sure that you have your heater model number and configuration number when calling.