

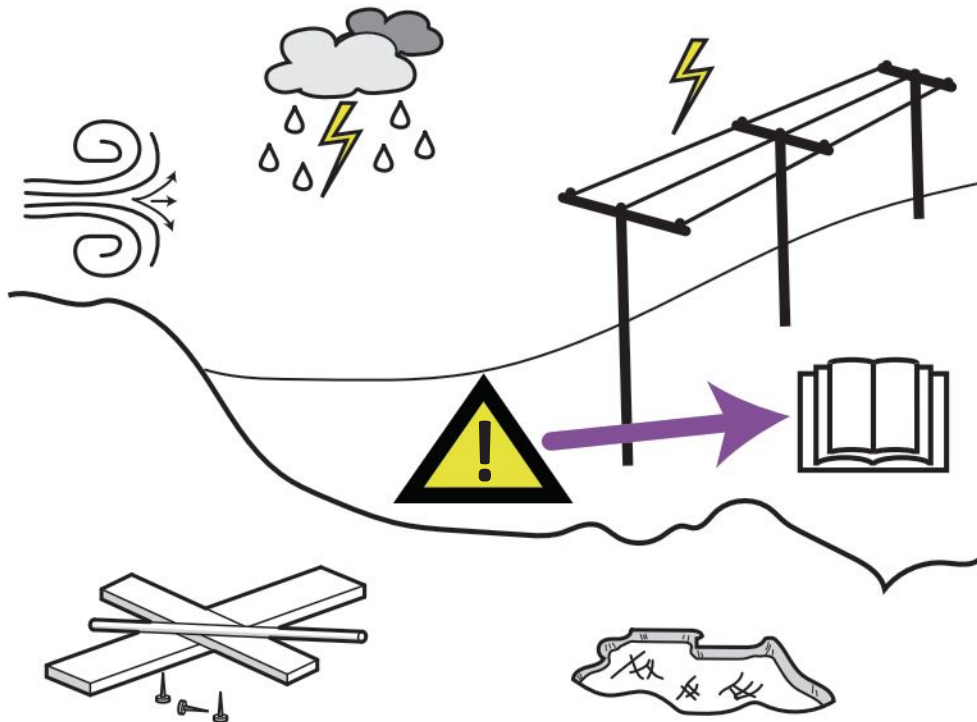

S/N A100 000 001 - A100 999 999  
S/N A101 000 001 - A101 999 999  
S/N A102 000 001 - A102 999 999  
S/N A103 000 001 - A103 999 999

SJ3215, SJ3219, SJ3220, SJ3226  
SJ4720, SJ4726, SJ4732, SJ4740  
ANSI/CSA, CE, AS, KC

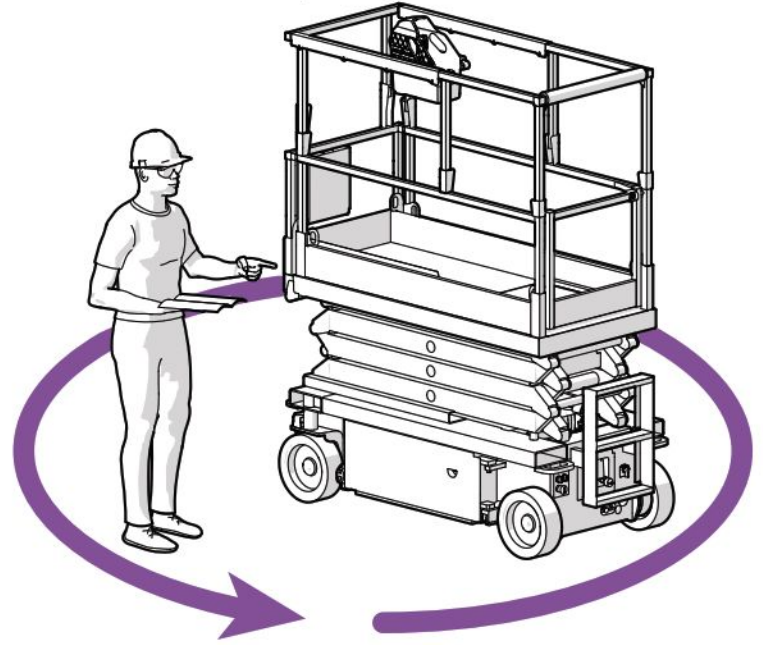

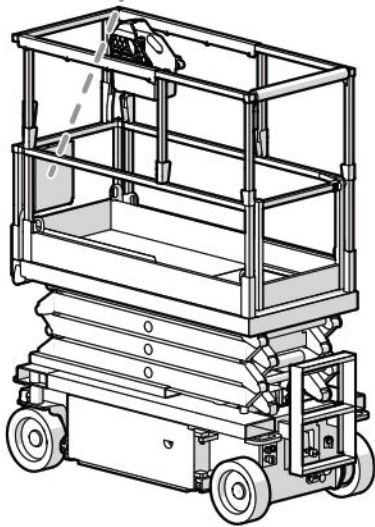
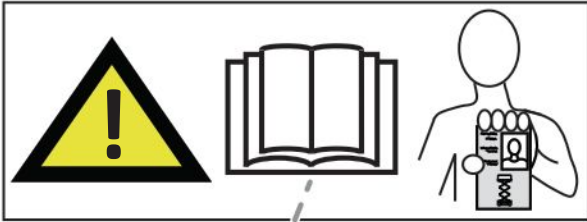
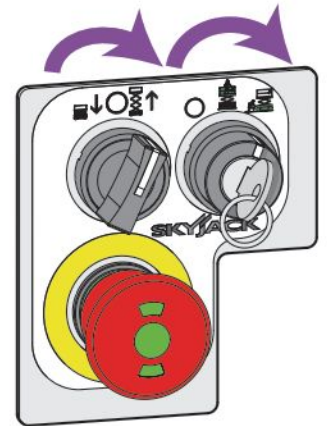
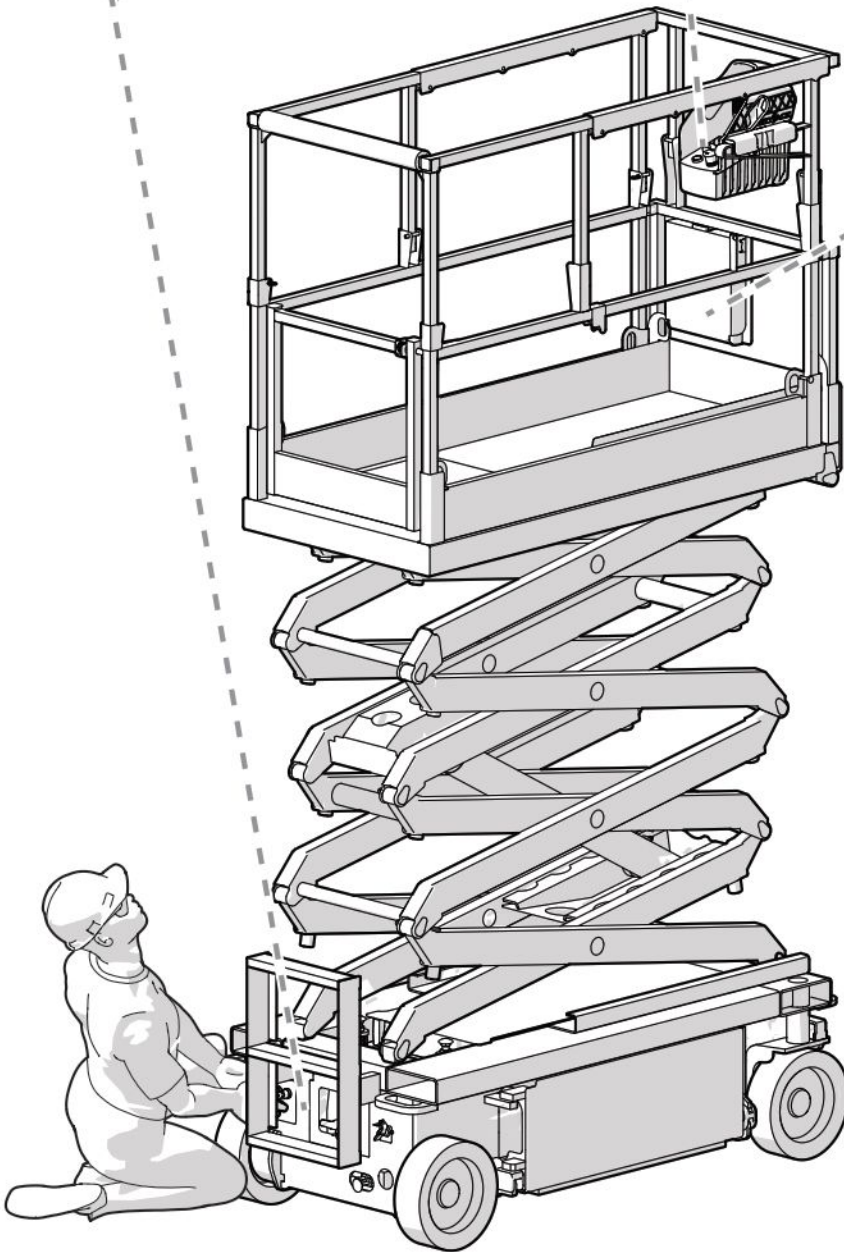
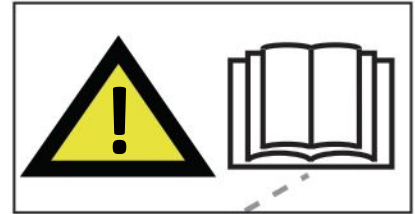
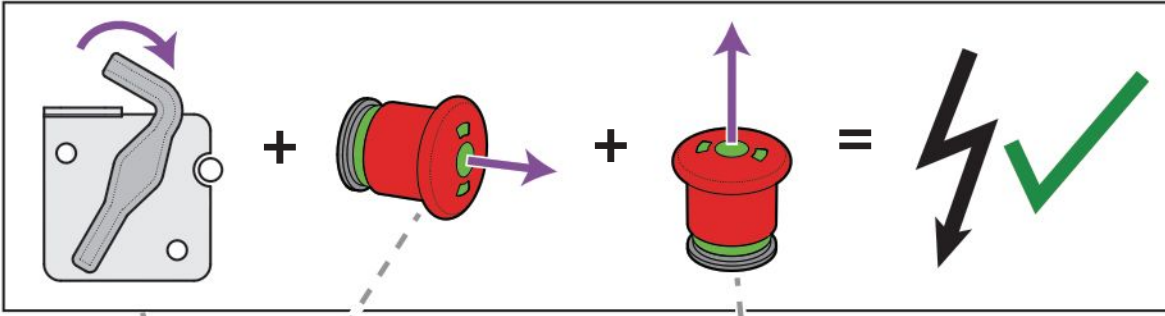

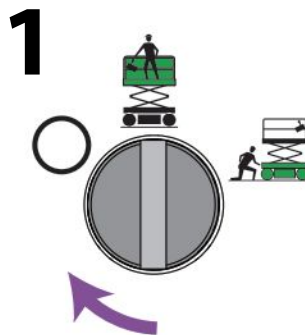
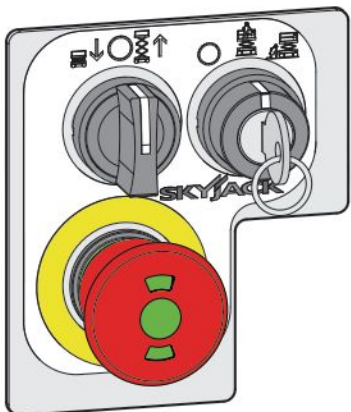
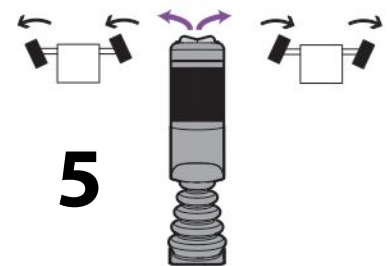
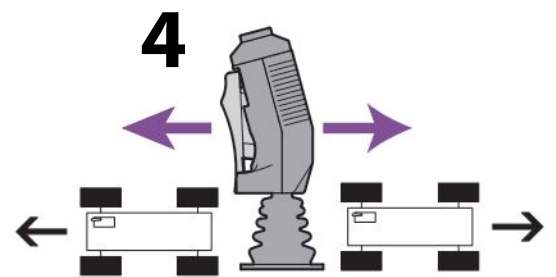
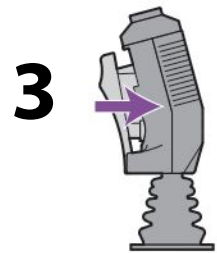
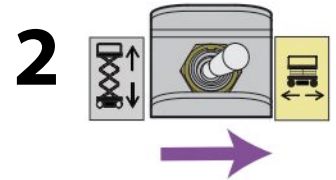
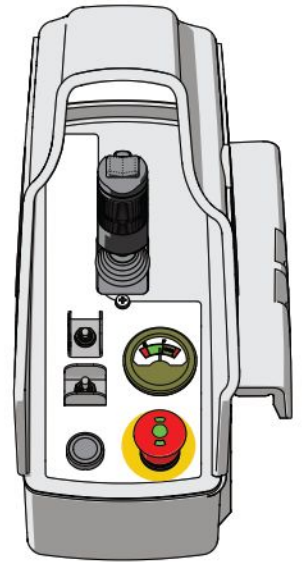
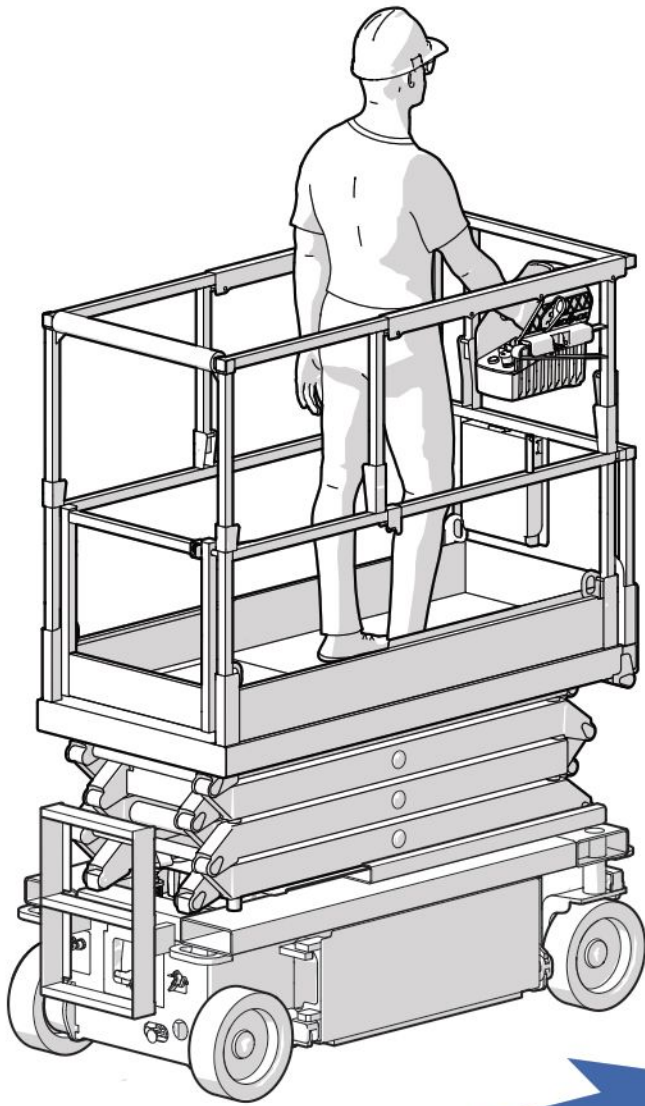

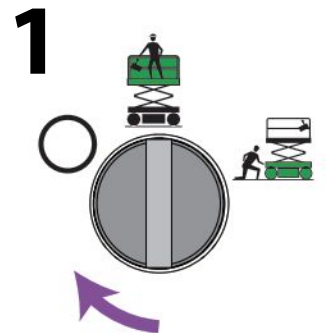
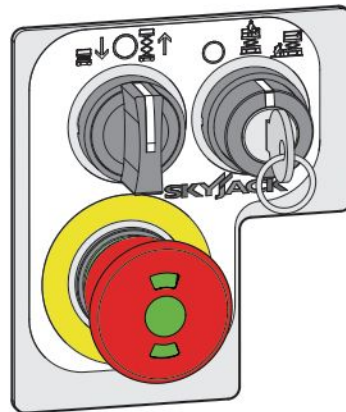
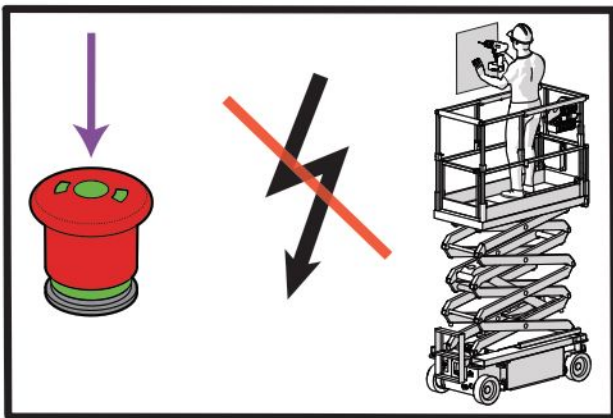
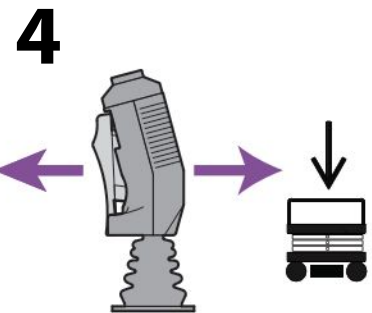
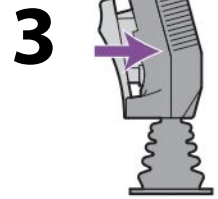
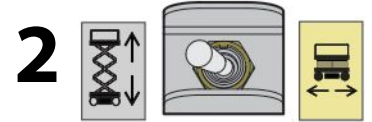
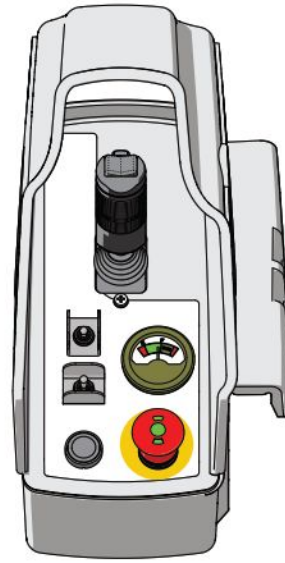
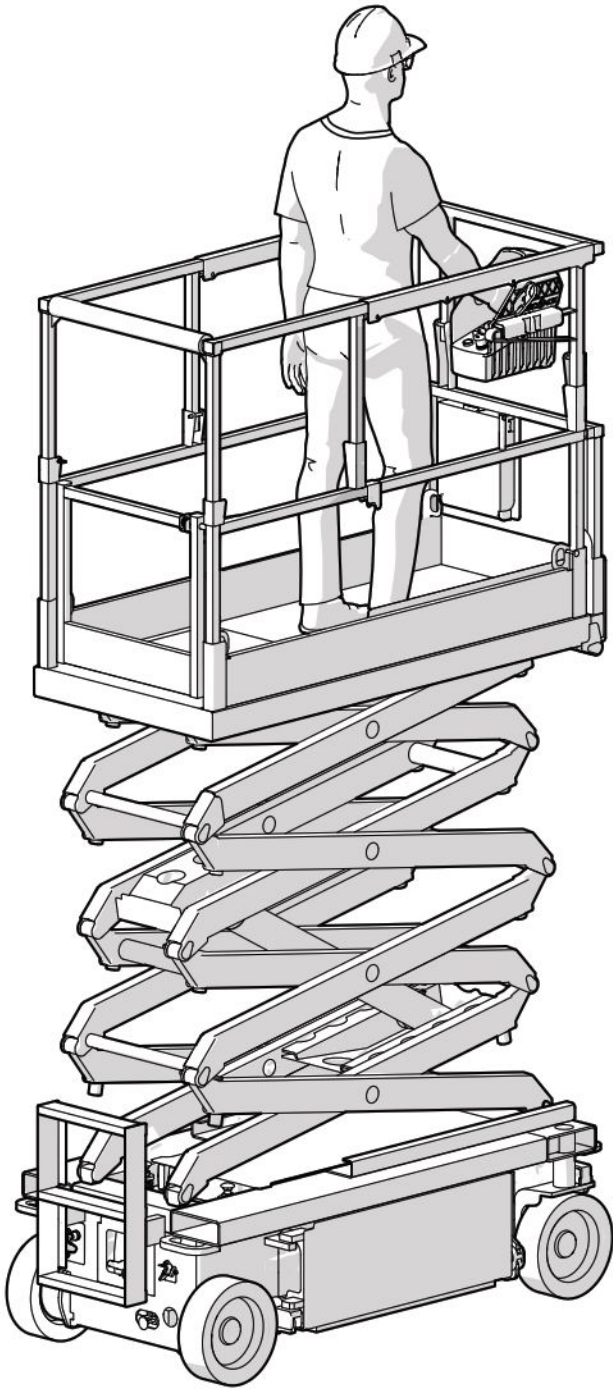

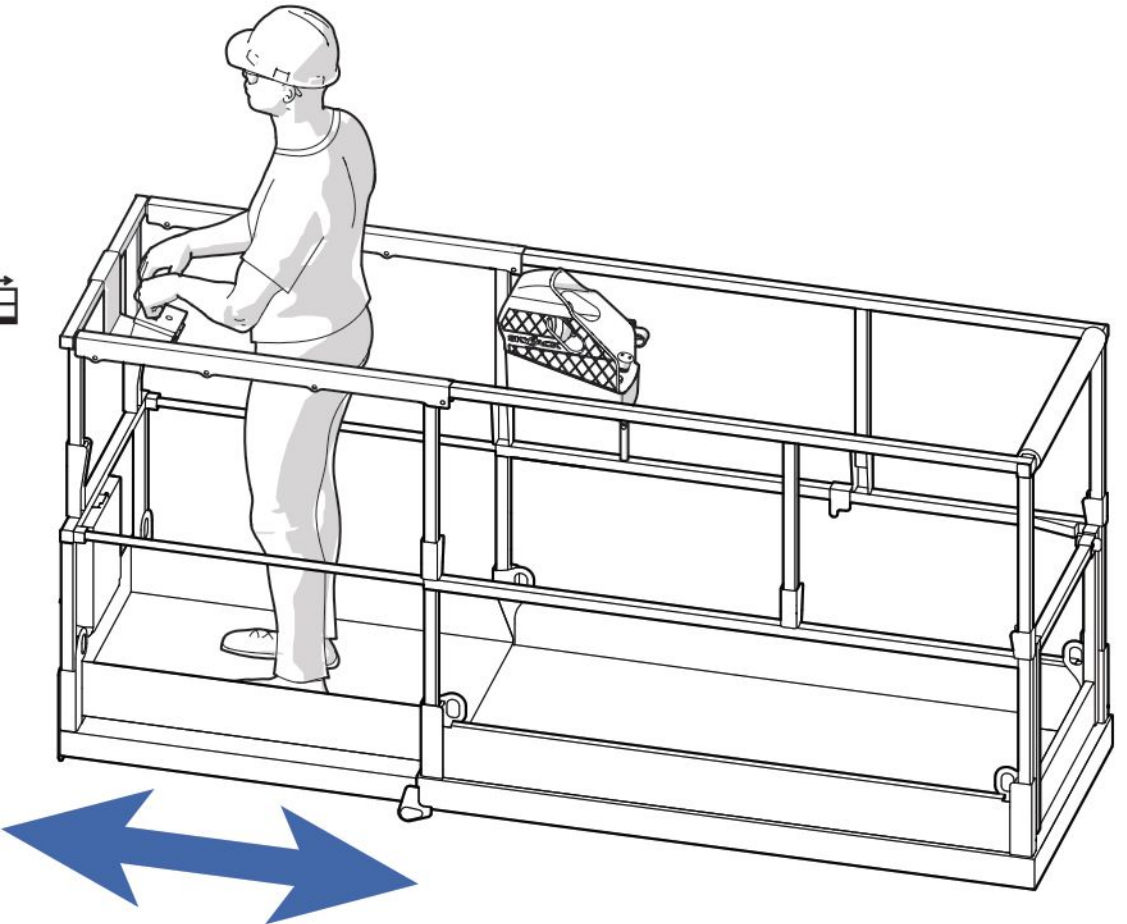
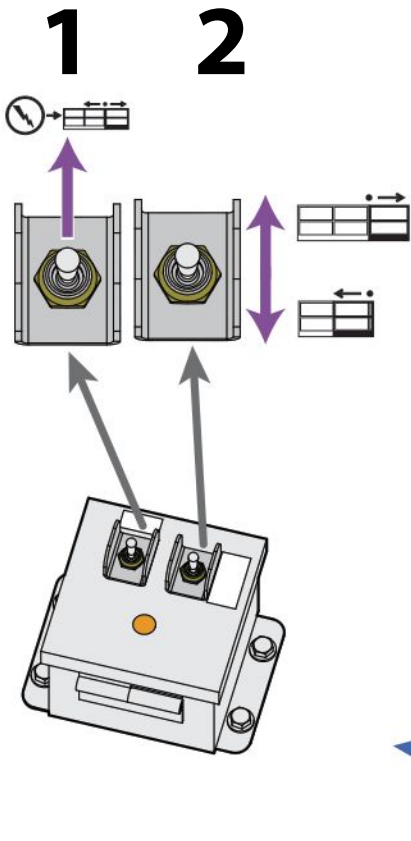
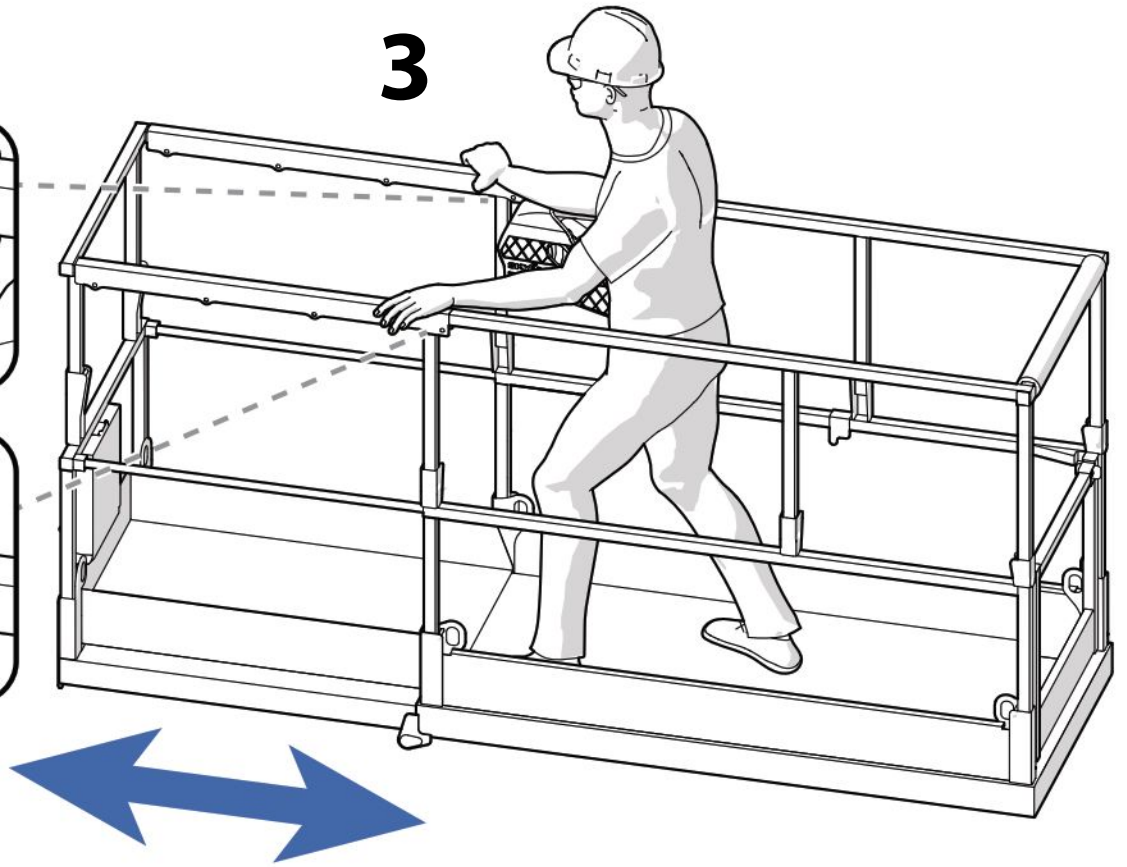
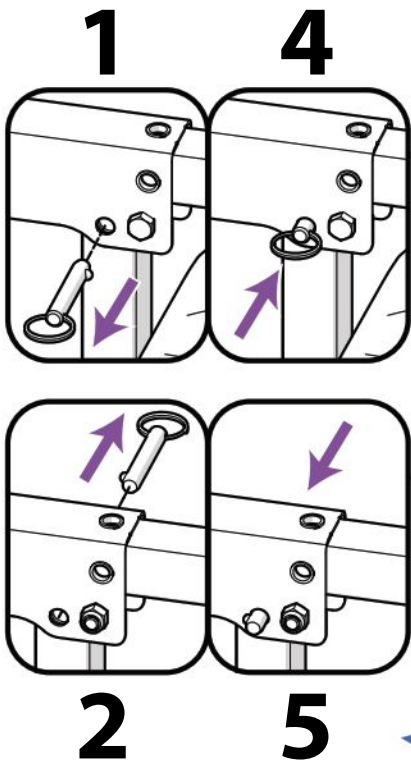

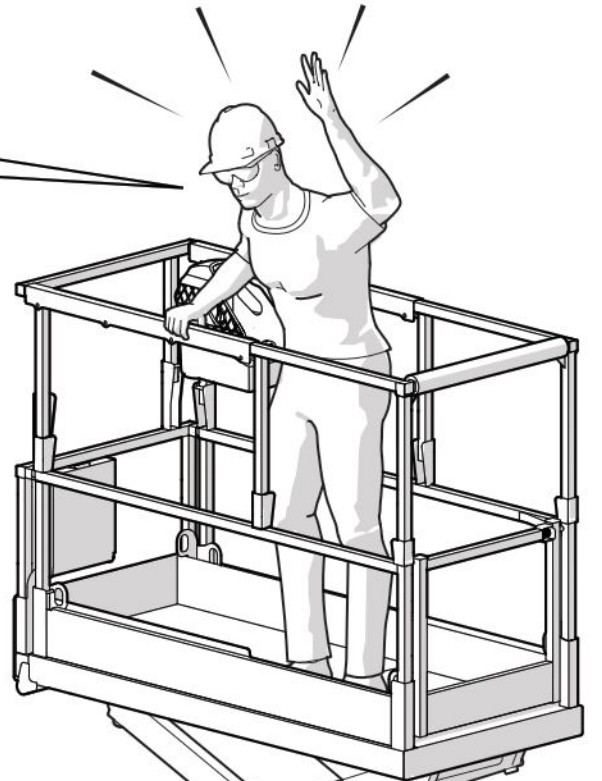
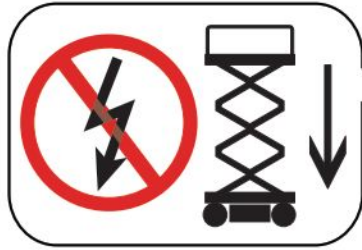

**1**

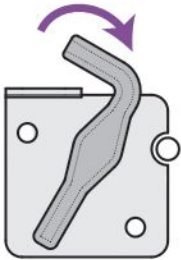

**2**

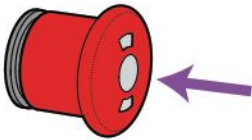

**3**

